

Specifications

Model No.	Power	Voltage	Wave length	Lamp type	Lamp base	Hold time	Lamp size	Operating Temp (°C/°F)	Life span	Weight (lbs=kgx2.2)	Color
U12-40W-01	40W±15%	120V(100-140V) 50-60Hz	254nm	UVC	G5	30/60/90/ 120mins/stay	704 x 67 x 54mm	-20~40°C -4~104°F	9,000H	NW:0.66kg GW:0.86kg	Matt Silver
U12-60W-01	60W±15%	120V(100-140V) 50-60Hz	254nm	UVC	G5	30/60/90/ 120mins/stay	1009 x 67 x 54mm	-20~40°C -4~104°F	9,000H	NW:0.89kg GW:1.16kg	Matt Silver
U12-80W-01	80W±15%	120V(100-140V) 50-60Hz	254nm	UVC	G5	30/60/90/ 120mins/stay	1313 x 67 x 54mm	-20~40°C -4~104°F	9,000H	NW:1.13kg GW:1.48kg	Matt Silver
U12-40W-02	40W±15%	230V(210-250V) 50-60Hz	254nm	UVC	G5	30/60/90/ 120mins/stay	704 x 67 x 54mm	-20~40°C -4~104°F	9,000H	NW:0.66kg GW:0.86kg	Matt Silver
U12-60W-02	60W±15%	230V(210-250V) 50-60Hz	254nm	UVC	G5	30/60/90/ 120mins/stay	1009 x 67 x 54mm	-20~40°C -4~104°F	9,000H	NW:0.89kg GW:1.16kg	Matt Silver
U12-80W-02	80W±15%	230V(210-250V) 50-60Hz	254nm	UVC	G5	30/60/90/ 120mins/stay	1313 x 67 x 54mm	-20~40°C -4~104°F	9,000H	NW:1.13kg GW:1.48kg	Matt Silver

Features

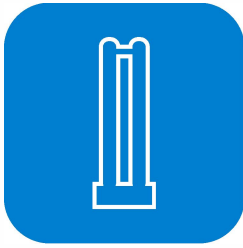

Quartz tube

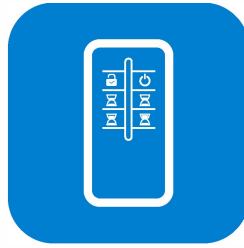

IR remote



20S delay start-up



Ozone-free UV



Microwave and PIR Sensor Built-in

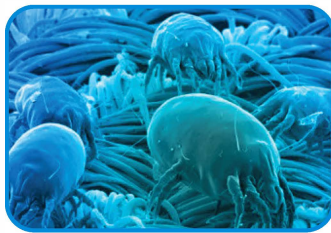

Effectively kill 99.99% mites



Effectively kill parasites

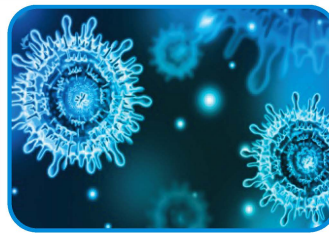

Effectively kill virus

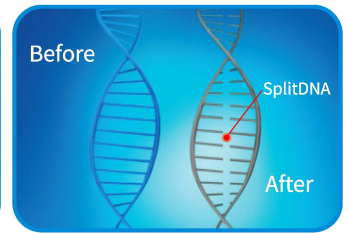

UV irradiation

Ozone-free UV lamp

Ultraviolet radiation rays is in a straight line, it is not disinfecting if it is blocked;

Usable area Power	Hold time	30mins	60mins	90mins	120mins
		40W	15 m ²	20 m ²	25 m ²
60W		20 m ²	30 m ²	35 m ²	40 m ²
80W		40 m ²	50 m ²	55 m ²	60 m ²

Microwave Sensor Built-in

Ceiling Mount
Top View

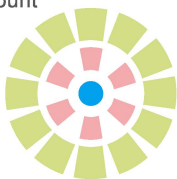

Top View

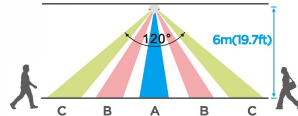

Wall Mount
Top View

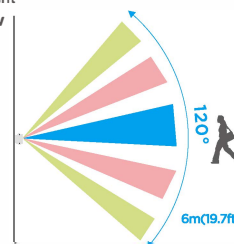

Top View

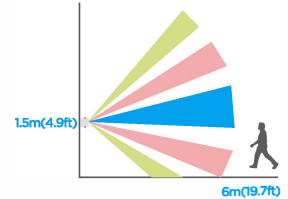

Features

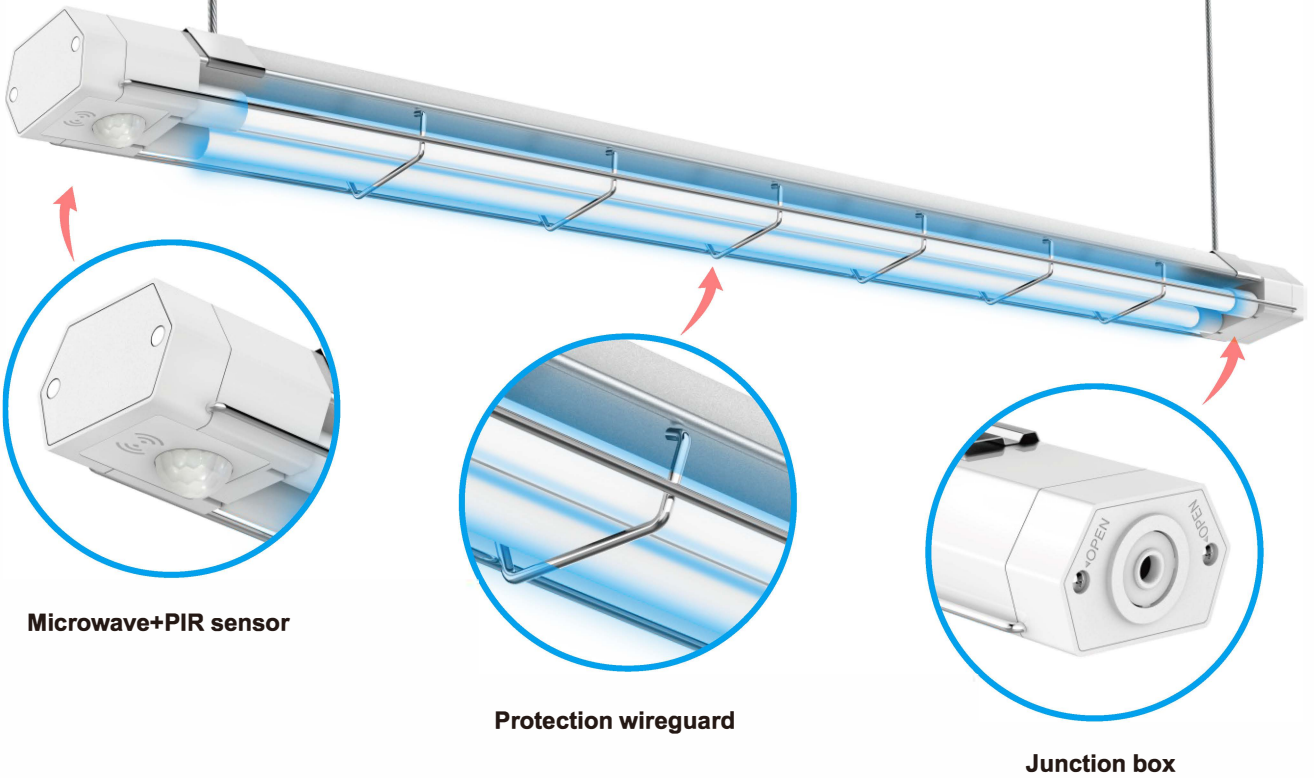

Microwave+PIR sensor

Protection wireguard

Junction box

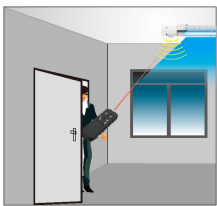

1

IR remoter, let you operate at a far distance, ensuring UVC light beaming never touch your

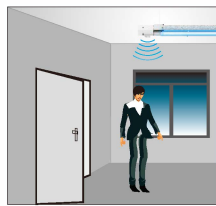

2

Built-in microwave+PIR
A. Once the human approaching the lamp, it will turn off automatically
B. Double security: Should both of the sensors dead, the lamp will never turn on, so as to ensure the human safety

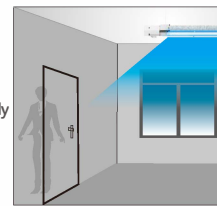

3

Built-in microwave and PIR
After detecting the human have left, the UVC lamp will turn on automatically, and back to the target work

Dimensions



2X40W 4FT
Size: L1313*W67*D54 mm



2X30W 3FT
Size: L1009*W67*D54 mm



2X20W 2FT
Size: L704*W67*D54 mm

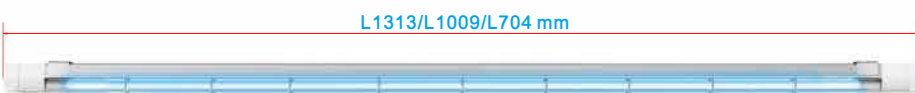

Application



U12 Installation

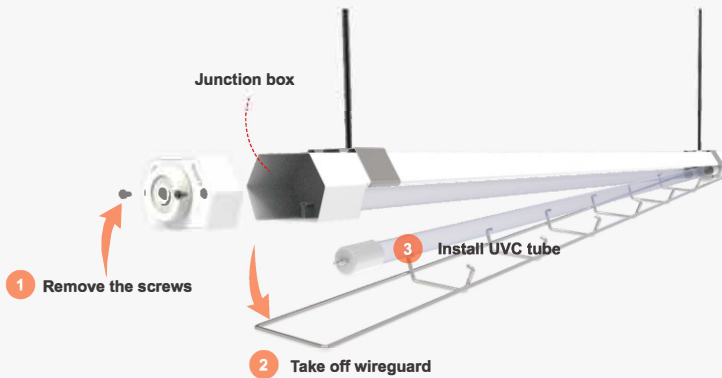

Different mounting installation

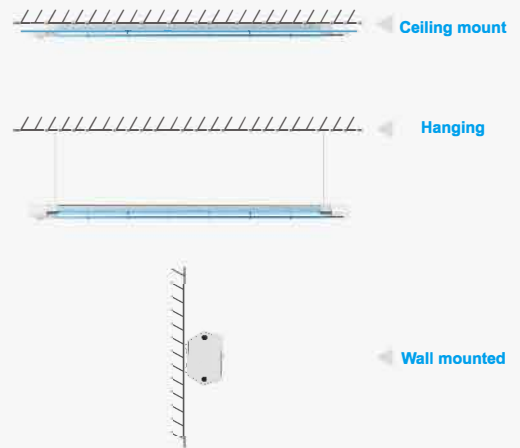

Packing

Model No.	Inner box size (mm) (x0.0393=inch)	N.W per lamp (kg) (lbs=kgx2.2)	G.W per lamp (kg) (lbs=kgx2.2)	G.W per Carton (kg) (lbs=kgx2.2)	Carton size (mm) (x0.0393=inch)	Quantity per carton
U12-40W	730x80x64mm	0.66Kg	0.86Kg	5.5Kg	750x260x148mm	6PCS
U12-60W	1035x80x64mm	0.89Kg	1.16Kg	7.5Kg	1055x260x148mm	6PCS
U12-80W	1340x80x64mm	1.13Kg	1.48Kg	9.6Kg	1360x260x148mm	6PCS

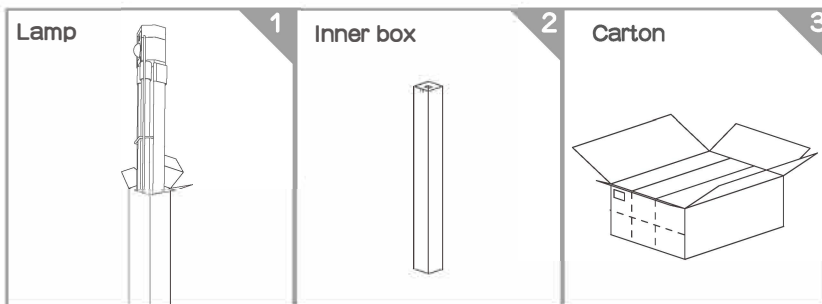

CAUTIONS

- Risk of electric shock. Do not use where directly exposed to water.
- Avoid UV light direct eyes and skin when turn on the lamp.
- Don't take apart the lamps without our permit.