

Specifications

Construction:

- Rugged one-piece, die-cast aluminum housing secures the thermally conductive LED panel and electrical chamber
- Low profile, 3G vibration rated compact design minimizes wind load requirements.
- Housing is completely sealed against moisture and environmental contaminants.

Optics:

- Available in IES Type III, IV, V distributions
- Light engines are available in standard 4000 K and 5000 K (70 CRI) configurations.
- Scalable Lumen Packages from 5,360 to 42,000 Lumens replaces up to 1000W Metal Halide.
- Optics is precisely designed to shape the distribution, maximizing efficiency and application spacing.
- For the ultimate level of spill light control, an optional house-side shield accessory can be field or factory installed.
- The optics can conform to dark sky requirement.

Electrical:

- Universal 120-277 VAC or 347-480 VAC input voltage
- Standard with 0-10V dimming driver(s)
- THD: $\leq 20\%$
- Power Factor: $\geq 90\%$

Controls:

- Optional occupancy sensor
- Optional Photocell

Ambient Temperature:

- Ambient operating temperature -40°C to 45°C (-40°F to 113°F).

Installation:

- Suitable for mounting heights ranging from 26-40' in area lighting applications
- Round pole, Square pole, slipfitter and wall mount are available
- The design can be operated by one person to install the whole lamp

Lifespan:

- Estimated 100,000-hour LED lifespan based on IES LM-80 results and TM-21 calculations

Finish:

- It's available in black or optional dark bronze, silvery gray or white.



Certifications:

- UL wet location listed and DLC qualified

Small Size: 40W/70W/100W



Medium Size: 150W/200W



Large Size: 250W/300W



Warranty:

Mester warrants that our LED products will be free from defects in materials and workmanship for a period of five (5) years from the date of delivery to the end user, including coverage of light output, color stability, driver performance and fixture finish. (For more information visit: <http://www.mesterleds.com/resources/warranty/>)

Note:

Actual performance may differ as a result of end-user environment and application. All values are design or typical values, measured under laboratory conditions at $25^{\circ}\text{C} (\pm 5^{\circ}\text{C})$ specifications subject to change without notice.

Applications:

Auto dealerships, parking lots, walkways, roadways, campuses, facade lighting, grocery stores and other public areas.



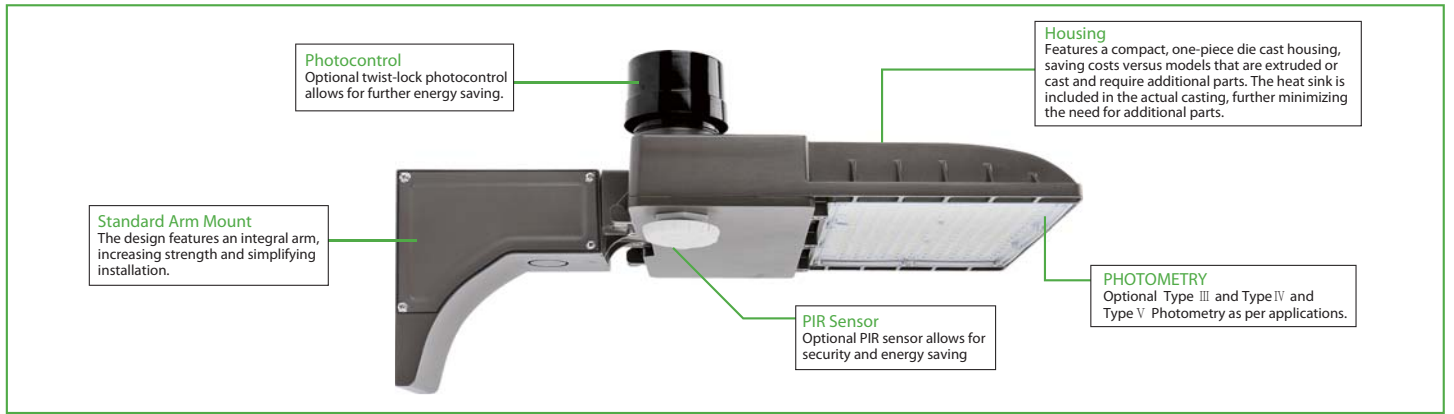







PERFORMANCE DATA

SYSTEM WATTS	VOLTAGE	DIST. TYPE	4000K(70CRI)		5000K(70CRI)	
			LUMENS	LPW	LUMENS	LPW
40W	120-277V	3	5400lm	135 lm/W	5500lm	138 lm/W
	120-277V	4	5360lm	134 lm/W	5480lm	137 lm/W
	120-277V	5	5600lm	140 lm/W	5720lm	143 lm/W
45W	347-480V	3	5900lm	131 lm/W	6000lm	133 lm/W
	347-480V	4	5850lm	130 lm/W	5940lm	132lm/W
	347-480V	5	6120lm	136 lm/W	6210lm	138 lm/W
70W	120-277V	3	9500lm	136 lm/W	9600lm	137 lm/W
	120-277V	4	9310lm	133 lm/W	9450lm	132 lm/W
	120-277V	5	9730lm	139 lm/W	9800lm	140 lm/W
75W	347-480V	3	9800lm	131 lm/W	10000lm	133 lm/W
	347-480V	4	9750lm	130 lm/W	9900lm	132 lm/W
	347-480V	5	10200lm	136 lm/W	10350lm	138 lm/W
100W	120-277V	3	13500lm	135 lm/W	13800lm	138 lm/W
	120-277V	4	13200lm	132 lm/W	13300lm	133 lm/W
	120-277V	5	13800lm	138 lm/W	13900lm	139 lm/W
150W	120-277V	3	20500lm	137 lm/W	20800lm	139 lm/W
	347-480V	3	21000lm	140 lm/W	21300lm	143 lm/W
	120-277V/347-480V	4	19800lm	132 lm/W	20000lm	133 lm/W
	120-277V	5	20500lm	137 lm/W	20800lm	139 lm/W
	347-480V	5	21000lm	140 lm/W	21000lm	140 lm/W
200W	120-277V/347-480V	3	25500lm	128 lm/W	26000lm	130 lm/W
	120-277V/347-480V	4	24600lm	123 lm/W	24800lm	124 lm/W
	120-277V/347-480V	5	25500lm	128 lm/W	26000lm	130 lm/W
250W	120-277V/347-480V	3	34000lm	136 lm/W	34500lm	138 lm/W
	120-277V/347-480V	4	33250lm	133 lm/W	33750lm	135 lm/W
	120-277V/347-480V	5	34750lm	139 lm/W	35250lm	141 lm/W
300W	120-277V	3	40500lm	135 lm/W	41000lm	137 lm/W
	347-480V	3	41500lm	138 lm/W	42000lm	140 lm/W
	120-277V/347-480V	4	39600lm	132 lm/W	39900lm	133 lm/W
	120-277V	5	40500lm	135 lm/W	41000lm	137 lm/W
	347-480V	5	41500lm	138 lm/W	42000lm	140 lm/W

ELECTRICAL DATA

Number Of Drivers	Driver Current (mA)	Nominal Power (W)	INPUT VOLTAGE (V)		CURRENT (Amps)
1	980	40	120		0.33
		40	208		0.19
		40	240		0.17
		40	277		0.14
		45	347		0.13
		45	480		0.09
1	1720	70	120		0.58
		70	208		0.34
		70	240		0.29
		70	277		0.25
		75	347		0.22
		75	480		0.16
1	2450	100	120		0.83
		100	208		0.48
		100	240		0.42
		100	277		0.36
		150	120		1.25
1	3900	150	208		0.72
		150	240		0.63
		150	277		0.54
		150	347		0.43
		150	480		0.31
		200	120		1.67
1	5100	200	208		0.96
		200	240		0.83
		200	277		0.72
		200	347		0.58
		200	480		0.42
		250	120		2.08
1	6400	250	208		1.20
		250	240		1.04
		250	277		0.90
		250	347		0.72
		250	480		0.52
		300	120		2.50
1	6000	300	208		1.44
		300	240		1.25
		300	277		1.08
		300	347		0.86
		300	480		0.63

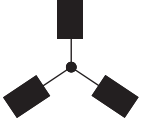
EPA OF AREA LIGHT

Item							
	1	2 @90°	2 @120°	2@180°	3 @90°	3 @120°	4 @90°
40W/70W/100W	0.3413	0.5929	0.7983	0.6826	1.0239	1.0499	1.0239
150W/200W	0.423	0.735	0.873	0.846	1.158	1.185	1.158
250W/300W	0.4759	0.7889	1.0581	0.9518	1.2648	1.3711	1.2648

BUG

SYSTEM WATTS	VOLTAGE	DIST.TYPE	B	U	G
40W	120-277V	3	1	0	1
45W	347-480V	3	1	0	1
70W	120-277V	3	2	0	2
75W	347-480V	3	2	0	2
100W	120-277V	3	2	0	2
150W	120-277V/347-480V	3	3	0	3
200W	120-277V/347-480V	3	3	0	3
250W	120-277V/347-480V	3	4	0	4
300W	120-277V/347-480V	3	4	0	4

MOUNTING

- Standard versatile mounting arm accommodates multiple drilling patterns as well as square and round poles
- Wall Mount available for direct wall mounting and J-box mounting
- Optional for cast aluminum slipfitter mounting adapter (Compatible with more MESTER mounting adaptors such as Tenon, suits for various application)

Mounting Options

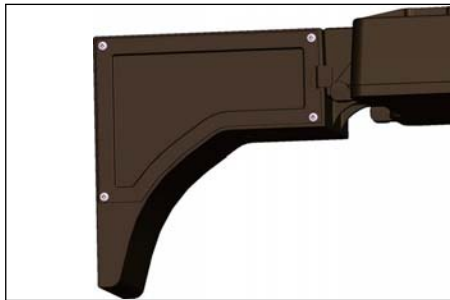

Arm Mount (4" and 5" Square and Round poles)
Standard versatile mounting arm is simple to install and can be used with existing poles for retrofit installations.

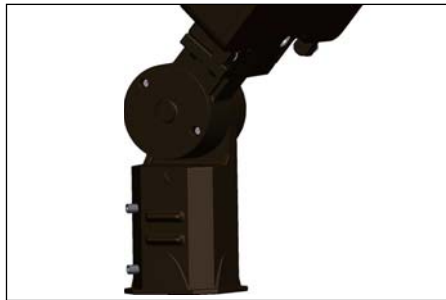

Slipfitter Mount
An optional cast aluminum mast arm adapter secures fixture head to nominal 2"(2-3/8" O.D. pipe size) horizontal steel tenon arm.



Wall Mount
Wall Mount is easy to install for direct wall mounting with 1/2" conduit wiring or standard J-box mounting

Mounting Dimensions

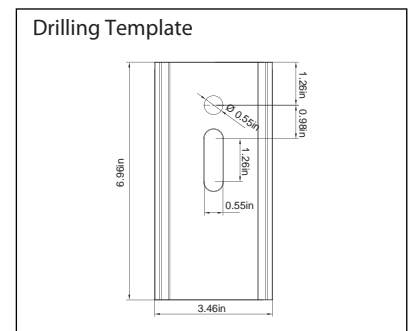
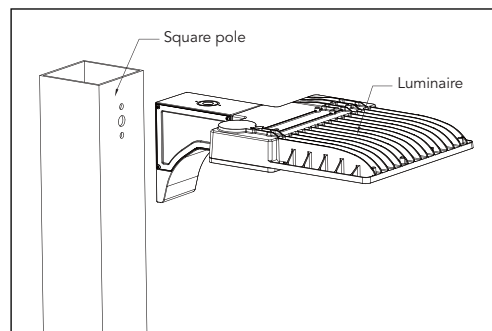
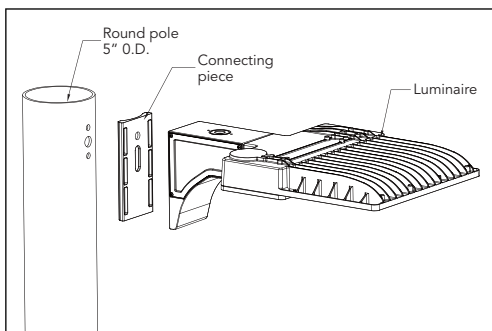

PHOTOMETRICS

Mester offers a complete set of optical systems to meet every site lighting requirement. These systems provide remarkable flexibility in precisely matching light distribution patterns to specific site requirements.

Type 3 optics produce an asymmetrical pattern that directs the majority of the light forward and equally on both sides of the luminaire. In a back-to-back configuration, it creates a rectangular pattern which can extend pole spacings.

Type 4 is suitable for applications where light is primarily required forward with minimal backlight. Typical installations include perimeter poles.

Type 5 optics produce a symmetrical square distribution pattern that distributes light equally on all sides of the luminaire. Type 5 luminaires is universal for most area lighting applications

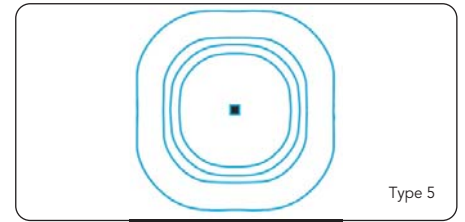
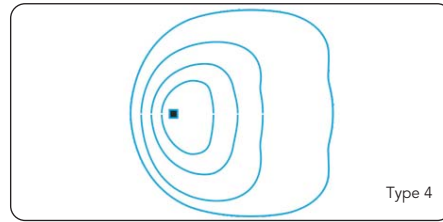
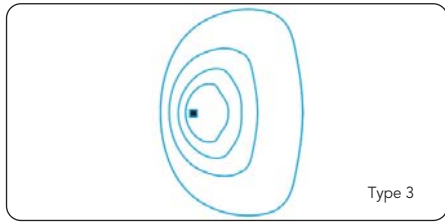

DIMENSION

unit: inch/mm

40W/70W/100W (Slipfitter Mount)

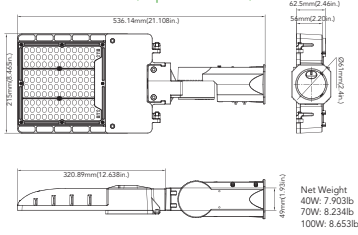

40W/70W/100W (Pole Mount)

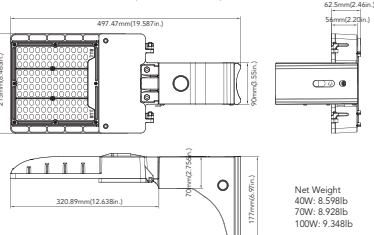

40W/70W/100W (Wall Mount)

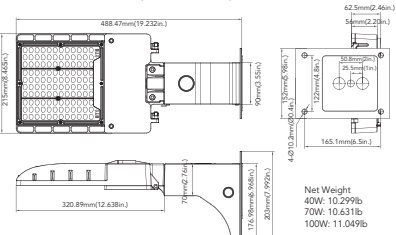

150W/200W (Slipfitter Mount)

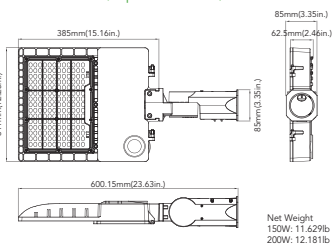

150W/200W (Pole Mount)

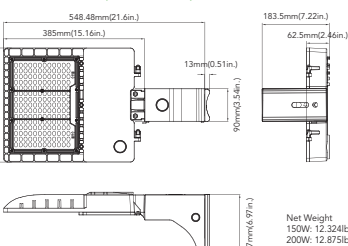

150W/200W (Wall Mount)

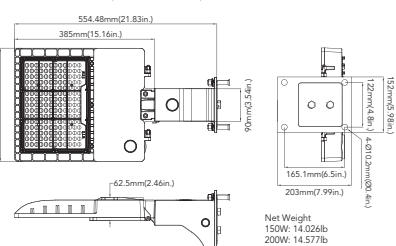

250W/300W (Slipfitter Mount)

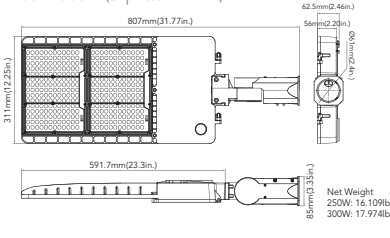

250W/300W (Pole Mount)

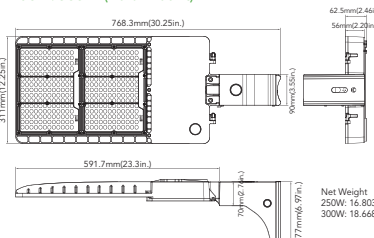

250W/300W (Wall Mount)

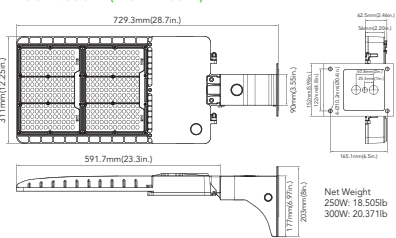

ORDERING GUIDE

Example: MAL04 100W 27V XXK Y Y Y Y Y

Fixture Type	Wattage	Voltage	CCT	Finish	Photocell (Option)	Sensor (Option)	Mounting	Photometry	Surge Protection (Option)
<input type="checkbox"/>	<input type="checkbox"/>	<input type="checkbox"/>	<input type="checkbox"/>	<input type="checkbox"/>	<input type="checkbox"/>	<input type="checkbox"/>	<input type="checkbox"/>	<input type="checkbox"/>	<input type="checkbox"/>
MAL04 Area Light Series	40 40W 45 45W 70 70W 75 75W 100 100W	27V 120-277V 48V 347-480V	40K 4000K 50K 5000K	D Dark Bronze B Black W White SG Silver Gray	P0 120-277V Photocell P3 347V Photocell P4 480V Photocell Blank Without Photocell	M With 120-277V Sensor Blank Without Sensor	SQ Square Pole Mount SP Slipfitter Mount WM Wall Mount	T3 TYPE III Photometry T4 TYPE IV Photometry T5 TYPE V Photometry	S Surge protection (Blank) No Surge protection

Note: 1. 100W is limited to 120-277V input only.
2. The Watt is 40W when the voltage is 120-277V, while when it is 347-480V, the watt is 45W.
3. The Watt is 70W when the voltage is 120-277V, while when it is 347-480V, the watt is 75W.

ORDERING GUIDE

Example: MAL04 150W 27V XXK Y Y Y Y Y

Fixture Type	Wattage	Voltage	CCT	Finish	Photocell (Option)	Sensor (Option)	Mounting	Photometry
<input type="checkbox"/>	<input type="checkbox"/>	<input type="checkbox"/>	<input type="checkbox"/>	<input type="checkbox"/>	<input type="checkbox"/>	<input type="checkbox"/>	<input type="checkbox"/>	<input type="checkbox"/>
MAL04 Area Light Series	150 150W 200 200W 250 250W 300 300W	27V 120-277V 48V 347-480V	40K 4000K 50K 5000K	D Dark Bronze B Black W White SG Silver Gray	P0 120-277V Photocell P3 347V Photocell P4 480V Photocell Blank Without Photocell	M With 120-277V Sensor Blank Without Sensor	SQ Square Pole Mount SP Slipfitter Mount WM Wall Mount	T3 TYPE III Photometry T4 TYPE IV Photometry T5 TYPE V Photometry

ADDITIONAL MOUNTING ACCESSORIES

POLE BRACKET • For mounting one fixture on an existing pole			
	<p>4" Square Pole Mount with 2-3/8" O.D. Tenon No. 4SQ-SP-D Finish: Dark Bronze USE: For use with square, non-tapered steel and aluminum poles. Furnished with four 5/16" hex head stainless-steel bolts. Vertical tenon measures 2-3/8" O.D., and is made of steel tubing. Fixtures mounted to this bracket can be adjusted both vertically and horizontally.</p>		<p>4" Round Pole Mount with 2-3/8" O.D. Tenon NO. 4SOR-SP-D Finish: Dark Bronze USE: For use with Round, non-tapered steel and aluminum poles. Furnished with three 3/8" hex head stainless-steel bolts. Vertical tenon measures 2-3/8" O.D., and is made of steel tubing. Fixtures mounted to this bracket can be adjusted both vertically and horizontally.</p>
	<p>5" Square Pole Mount with 2-3/8" O.D. Tenon No. 5SQ-SP-D Finish: Dark Bronze USE: For use with square, non-tapered steel and aluminum poles. Furnished with four 5/16" hex head stainless-steel bolts. Vertical tenon measures 2-3/8" O.D., and is made of steel tubing. Fixtures mounted to this bracket can be adjusted both vertically and horizontally.</p>		<p>5" Round Pole Mount with 2-3/8" O.D. Tenon NO. 5SOR-SP-D Finish: Dark Bronze USE: For use with Round, non-tapered steel and aluminum poles. Furnished with three 3/8" hex head stainless-steel bolts. Vertical tenon measures 2-3/8" O.D., and is made of steel tubing. Fixtures mounted to this bracket can be adjusted both vertically and horizontally.</p>
	<p>Pole Bracket accessories-Tenon & Yoke Adaptor NO. SP-TR-D Finish: Dark Bronze USE: The 2-3/8" OD Tenon Mount Adaptor for Yoke Fixtures is designed to mount MESTER light fixtures that are equipped with a yoke mount onto a 2-3/8" OD tenon. It may be utilized with the Mester Flood Light Series of light fixtures.</p>		
WALL BRACKET • Attaches to any flat surface • Provides wiring access		Mid-Pole tenon Bracket	
	<p>90° Wall Mount Bracket with 2-3/8" O.D. Tenon NO. WM-SP-D Finish: Dark Bronze USE: The 90° wall mount bracket with 2-3/8" tenon attaches an MESTER floodlight to almost any surface: wall, roof, or wood pole. Provides wiring access and a built-in 2-3/8" O.D. tenon to mount a fixture with our adjustable slipfitter. Suggested 3/8" diameter bolts for mounting. Mounting holes are spaced 3-1/4" apart.</p>		<p>2-3/8" OD Horizontal Tenon Mid-Pole Bracket NO. SQ-SP-D Finish: Dark Bronze USE: 2-3/8" OD Horizontal Tenon Mid-Pole Bracket is designed to mount light fixture that is equipped with an adjustable slipfitter onto a 2-3/8" OD horizontal tenon</p>
Round External Mount Horizontal Tenon • To mount 2/3/4 fixtures on a existing pole			
	<p>Double 90° Horizontal Tenon Adaptor NO. R60-SP2-90-D Finish: Dark Bronze USE: The Bracket is designed to mount over 2-3/8" (60mm) O.D. vertical tenon. Two fixtures can be mounted to the Round External Mount Horizontal Tenon and adjusted horizontally</p>		<p>Triple 120° Horizontal Tenon Adaptor NO. R60-SP3-120-D Finish: Dark Bronze USE: The Bracket is designed to mount over 2-3/8" (60mm) O.D. vertical tenon. Three fixtures can be mounted to the Round External Mount Horizontal Tenon and adjusted horizontally</p>
	<p>Double 180° Horizontal Tenon Adaptor NO. R60-SP2-180-D Finish: Dark Bronze USE: The Bracket is designed to mount over 2-3/8" (60mm) O.D. vertical tenon. Two fixtures can be mounted to the Round External Mount Horizontal Tenon and adjusted horizontally</p>		<p>Quad 90° Horizontal Tenon Adaptor NO. R60-SP4-90-D Finish: Dark Bronze USE: The Bracket is designed to mount over 2-3/8" (60mm) O.D. vertical tenon. Four fixtures can be mounted to the Round External Mount Horizontal Tenon and adjusted horizontally</p>
	<p>Triple 90° Horizontal Tenon Adaptor NO. R60-SP3-90-D Finish: Dark Bronze USE: The Bracket is designed to mount over 2-3/8" (60mm) O.D. vertical tenon. Three fixtures can be mounted to the Round External Mount Horizontal Tenon and adjusted horizontally</p>		

DLC Model NO.

SYSTEM WATTS	VOLTAGE	CCT	DIST. TYPE	DLC NO.	DLC Classification
40W	120-277V	4000K	3	MAL0440W27V40K[D, B, W, SG][Blank, P0, P3, P4][Blank, M][SQ, SP, WM]T3	Premium
		5000K	3	MAL0440W27V50K[D, B, W, SG][Blank, P0, P3, P4][Blank, M][SQ, SP, WM]T3	Premium
70W	120-277V	4000K	3	MAL0470W27V40K[D, B, W, SG][Blank, P0, P3, P4][Blank, M][SQ, SP, WM]T3	Premium
		5000K	3	MAL0470W27V50K[D, B, W, SG][Blank, P0, P3, P4][Blank, M][SQ, SP, WM]T3	Premium
100W	120-277V	4000K	3	MAL04100W27V40K[D, B, W, SG][Blank, P0, P3, P4][Blank, M][SQ, SP, WM]T3	Premium
		5000K	3	MAL04100W27V50K[D, B, W, SG][Blank, P0, P3, P4][Blank, M][SQ, SP, WM]T3	Premium
150W	120-277V	4000K	3	MAL04150W27V40K[D, B, W, SG][Blank, P0, P3, P4][Blank, M][SQ, SP, WM]T3	Premium
		5000K	3	MAL04150W27V50K[D, B, W, SG][Blank, P0, P3, P4][Blank, M][SQ, SP, WM]T3	Premium
		4000K	5	MAL04150W27V40K[D, B, W, SG][Blank, P0, P3, P4][Blank, M][SQ, SP, WM]T5	Premium
		5000K	5	MAL04150W27V50K[D, B, W, SG][Blank, P0, P3, P4][Blank, M][SQ, SP, WM]T5	Premium
	347-480V	4000K	3	MAL04150W48V40K[D, B, W, SG][Blank, P0, P3, P4][Blank, M][SQ, SP, WM]T3	Premium
		5000K	3	MAL04150W48V50K[D, B, W, SG][Blank, P0, P3, P4][Blank, M][SQ, SP, WM]T3	Premium
		4000K	5	MAL04150W48V40K[D, B, W, SG][Blank, P0, P3, P4][Blank, M][SQ, SP, WM]T5	Premium
		5000K	5	MAL04150W48V50K[D, B, W, SG][Blank, P0, P3, P4][Blank, M][SQ, SP, WM]T5	Premium
200W	120-277V	4000K	3	MAL04200W27V40K[D, B, W, SG][Blank, P0, P3, P4][Blank, M][SQ, SP, WM]T3	Premium
		5000K	3	MAL04200W27V50K[D, B, W, SG][Blank, P0, P3, P4][Blank, M][SQ, SP, WM]T3	Premium
		4000K	5	MAL04200W27V40K[D, B, W, SG][Blank, P0, P3, P4][Blank, M][SQ, SP, WM]T5	Standard
		5000K	5	MAL04200W27V50K[D, B, W, SG][Blank, P0, P3, P4][Blank, M][SQ, SP, WM]T5	Standard
	347-480V	4000K	3	MAL04200W48V40K[D, B, W, SG][Blank, P0, P3, P4][Blank, M][SQ, SP, WM]T3	Standard
		5000K	3	MAL04200W48V50K[D, B, W, SG][Blank, P0, P3, P4][Blank, M][SQ, SP, WM]T3	Standard
		4000K	5	MAL04200W48V40K[D, B, W, SG][Blank, P0, P3, P4][Blank, M][SQ, SP, WM]T5	Standard
		5000K	5	MAL04200W48V50K[D, B, W, SG][Blank, P0, P3, P4][Blank, M][SQ, SP, WM]T5	Standard
300W	120-277V	4000K	3	MAL04300W27V40K[D, B, W, SG][Blank, P0, P3, P4][Blank, M][SQ, SP, WM]T3	Premium
		5000K	3	MAL04300W27V50K[D, B, W, SG][Blank, P0, P3, P4][Blank, M][SQ, SP, WM]T3	Premium
		4000K	5	MAL04300W27V40K[D, B, W, SG][Blank, P0, P3, P4][Blank, M][SQ, SP, WM]T5	Premium
		5000K	5	MAL04300W27V50K[D, B, W, SG][Blank, P0, P3, P4][Blank, M][SQ, SP, WM]T5	Premium
	347-480V	4000K	3	MAL04300W48V40K[D, B, W, SG][Blank, P0, P3, P4][Blank, M][SQ, SP, WM]T3	Premium
		5000K	3	MAL04300W48V50K[D, B, W, SG][Blank, P0, P3, P4][Blank, M][SQ, SP, WM]T3	Premium
		4000K	5	MAL04300W48V40K[D, B, W, SG][Blank, P0, P3, P4][Blank, M][SQ, SP, WM]T5	Premium
		5000K	5	MAL04300W48V50K[D, B, W, SG][Blank, P0, P3, P4][Blank, M][SQ, SP, WM]T5	Premium