

LED RETROFIT KITS

High quality lighting
Easy installation
Safe and environmentally friendly
Better Design
Saving Energy



Features

Power rate 300W
ETL cETL DLC approved
Meanwell driver
AC100-277V input
Rotable Design
SMD3030 LED chips
135~145lm/W
120 degree beam angle
Unique Cooling System designed with an aluminum fin heat sink
Adjust 180 degree.E40 E39 socket
High Lumens LED Chips
5 years warranty

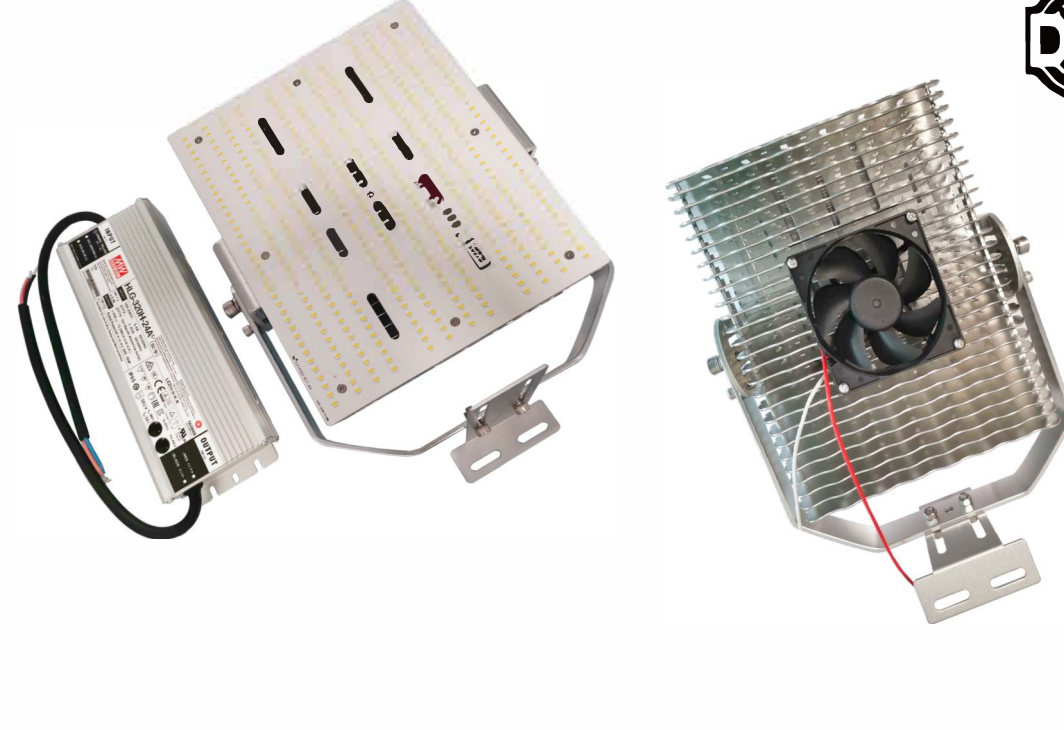

Applications

schools, garden, parking lots, public parks etc.
LED Retrofit Kits series can be widely used in parking lot, Tennis Court,Canopy gas station.

Series	Lumens	Base	Beam Angle (Degree)	Electrical Data	LED Type	Color temperature	Color rendering index
NGRK-300W	4350LM 43,500 lumens	E39,E40	120 degree	Input Voltage 100-277V 50-60Hz Power Factor(%) >90	(300W) SMD3030 chips 432pcs LED chips	WW 3000 K NW 4000 K DW 5000 K CW 5700 K	70 70 CRI 80 80 CRI 90 90 CRI

WWW.ECOMAXLIGHTING.COM

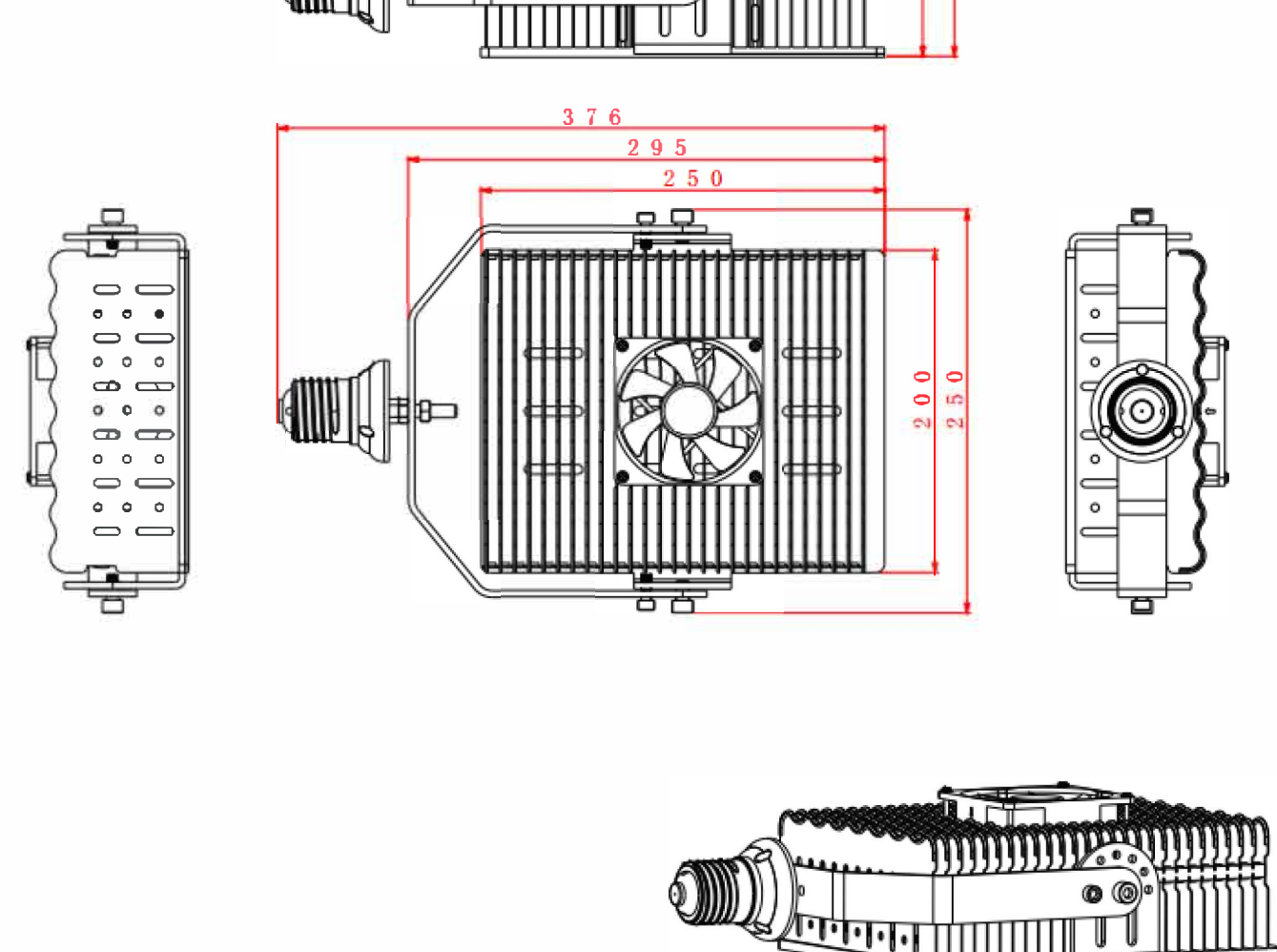

Power	Unit	Size	Gross weight
300W	1pcs	39*35*14cm	4.8kg
	3pcs	47*42*38cm	14.5kg

WWW.ECOMAXLIGHTING.COM

E39 E40 Retrofit kit with Meanwell driver:

- ① E39 E40 base install in fixture socket
- ② Output of Meanwell driver connect with fixture socket
Red(DC+) connect Meanwell driver red line(L),
Black(DC-) connect Meanwell driver black line(N)
- ③ Input of Meanwell driver connect 100~277VAC
Green / Yellow(E) connect PE. Brown(AC+) connect L
Blue(AC-) connect N
- ④ Turn on the light.

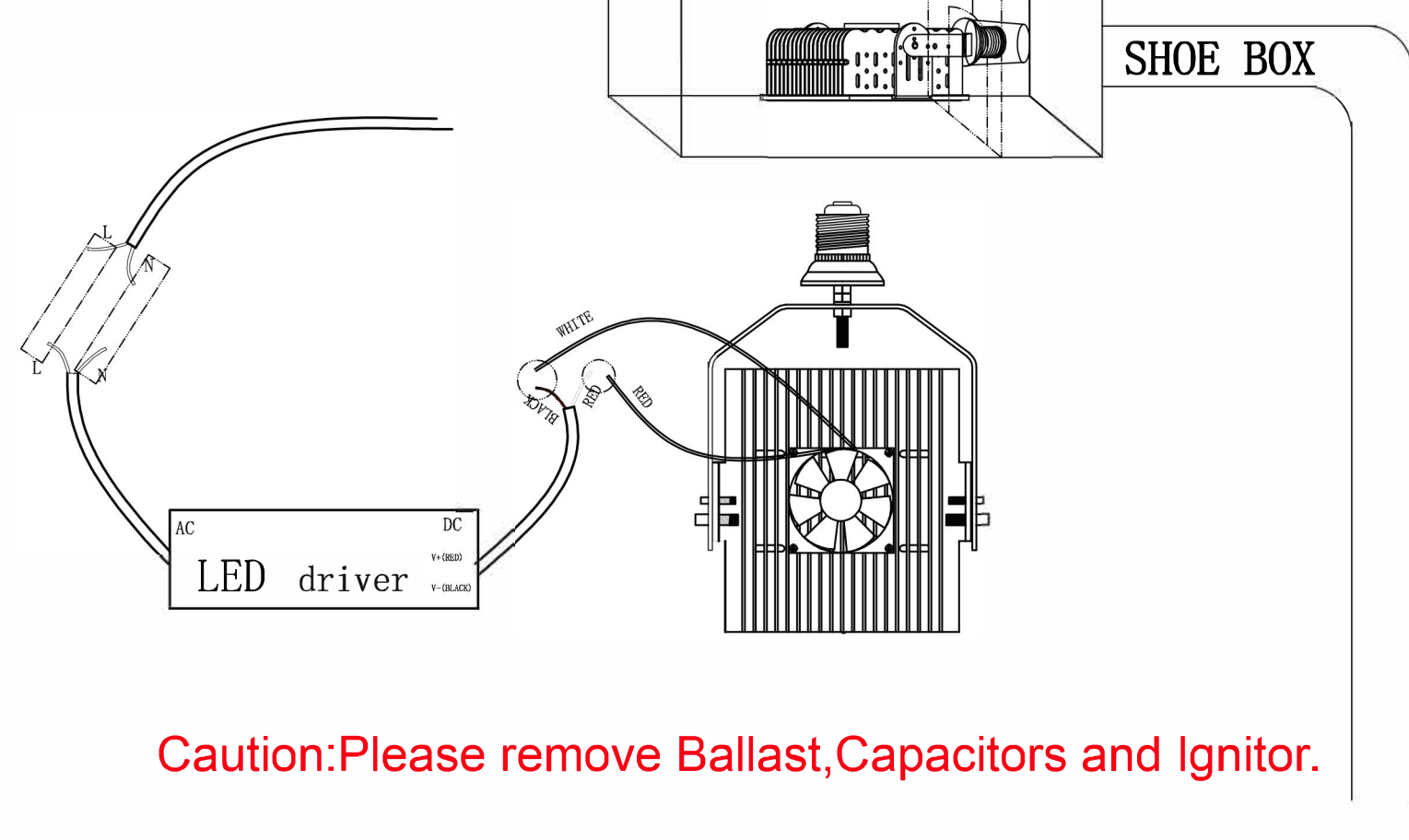

Caution:Please remove Ballast,Capacitors and Ignitor.

WWW.ECOMAXLIGHTING.COM

Installation 1



Installation 2

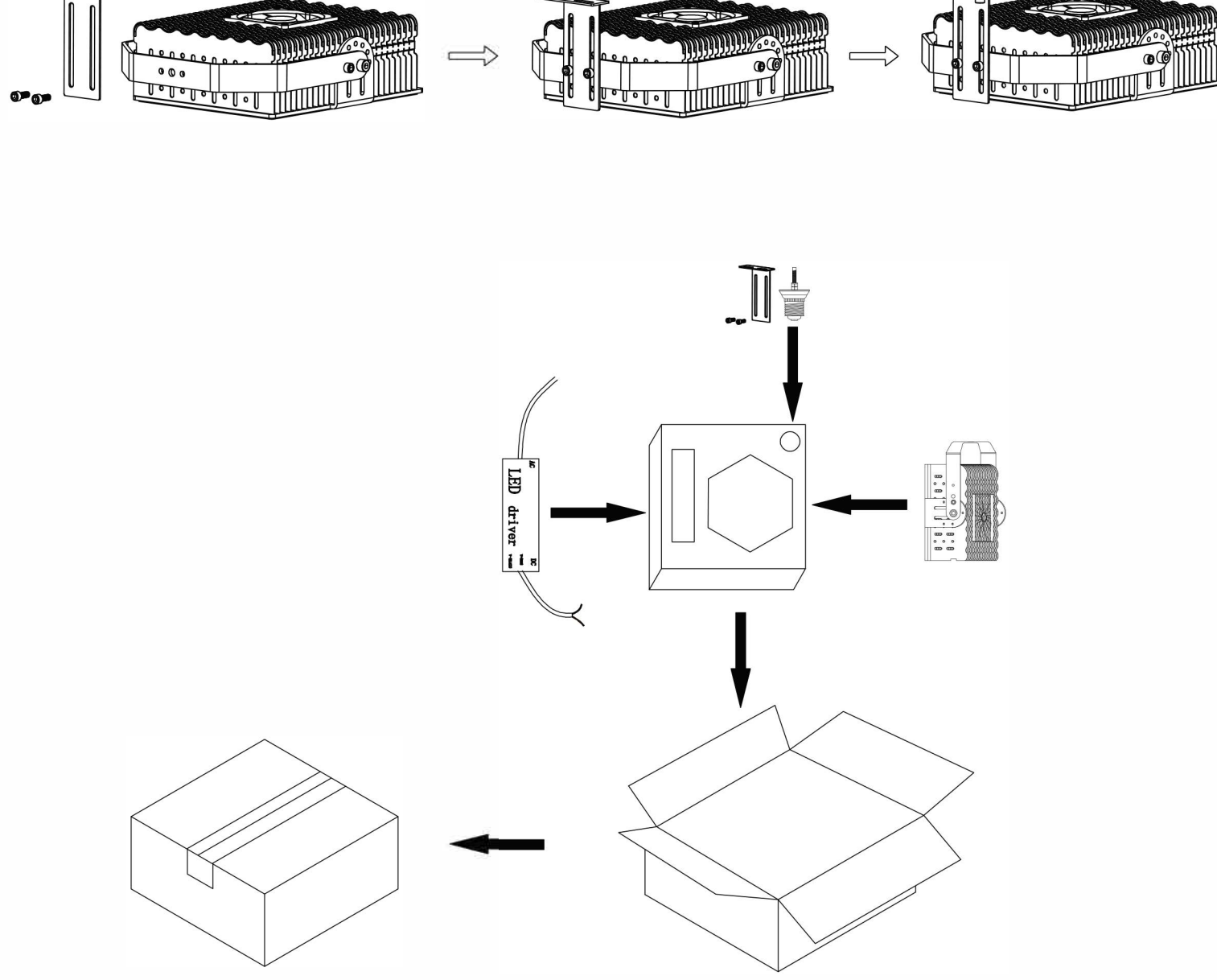

WWW.ECOMAXLIGHTING.COM

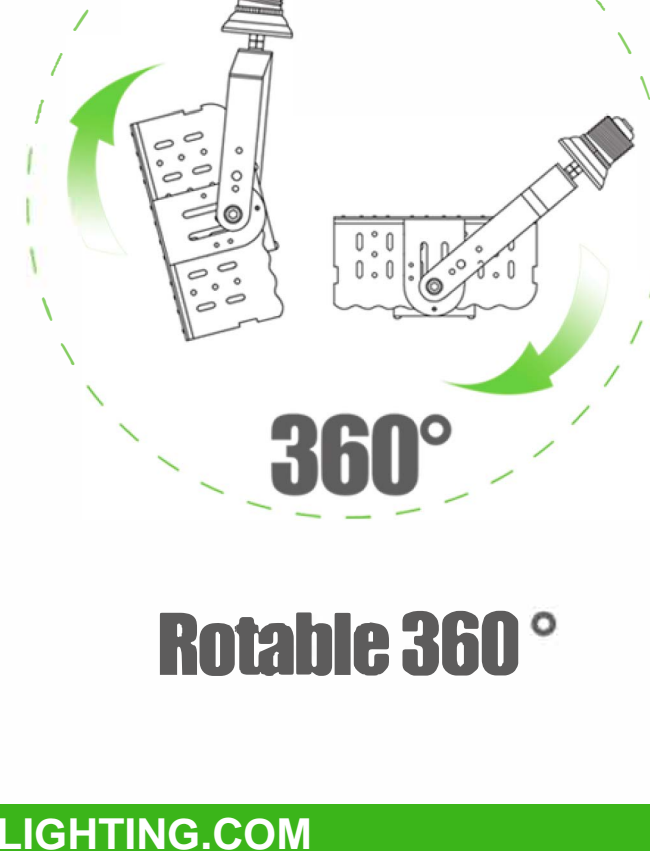
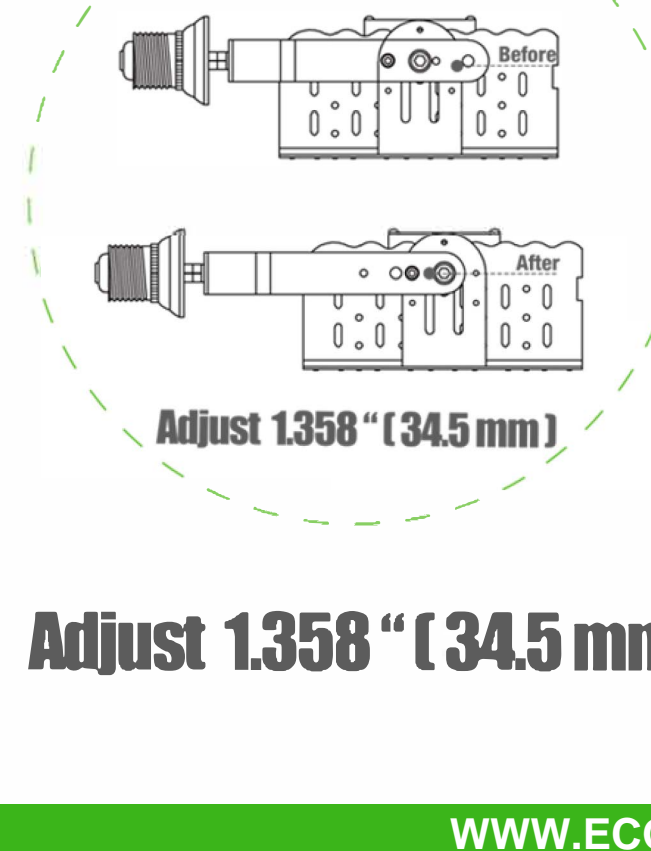
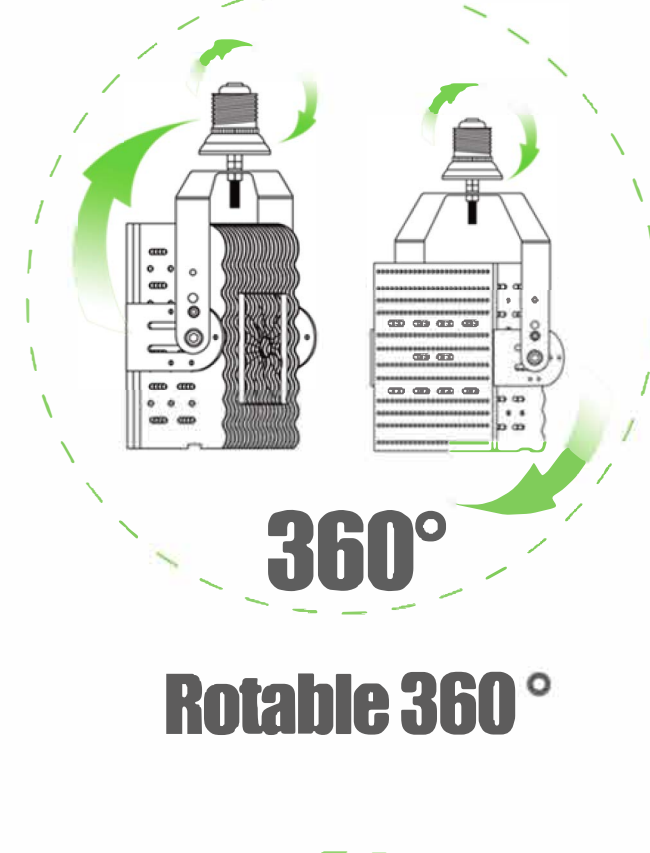
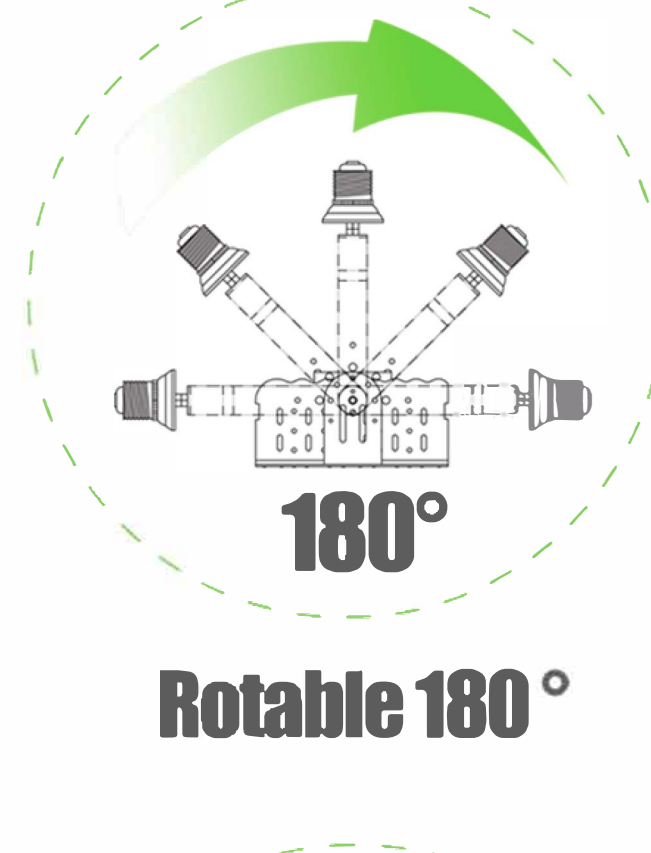

WWW.ECOMAXLIGHTING.COM

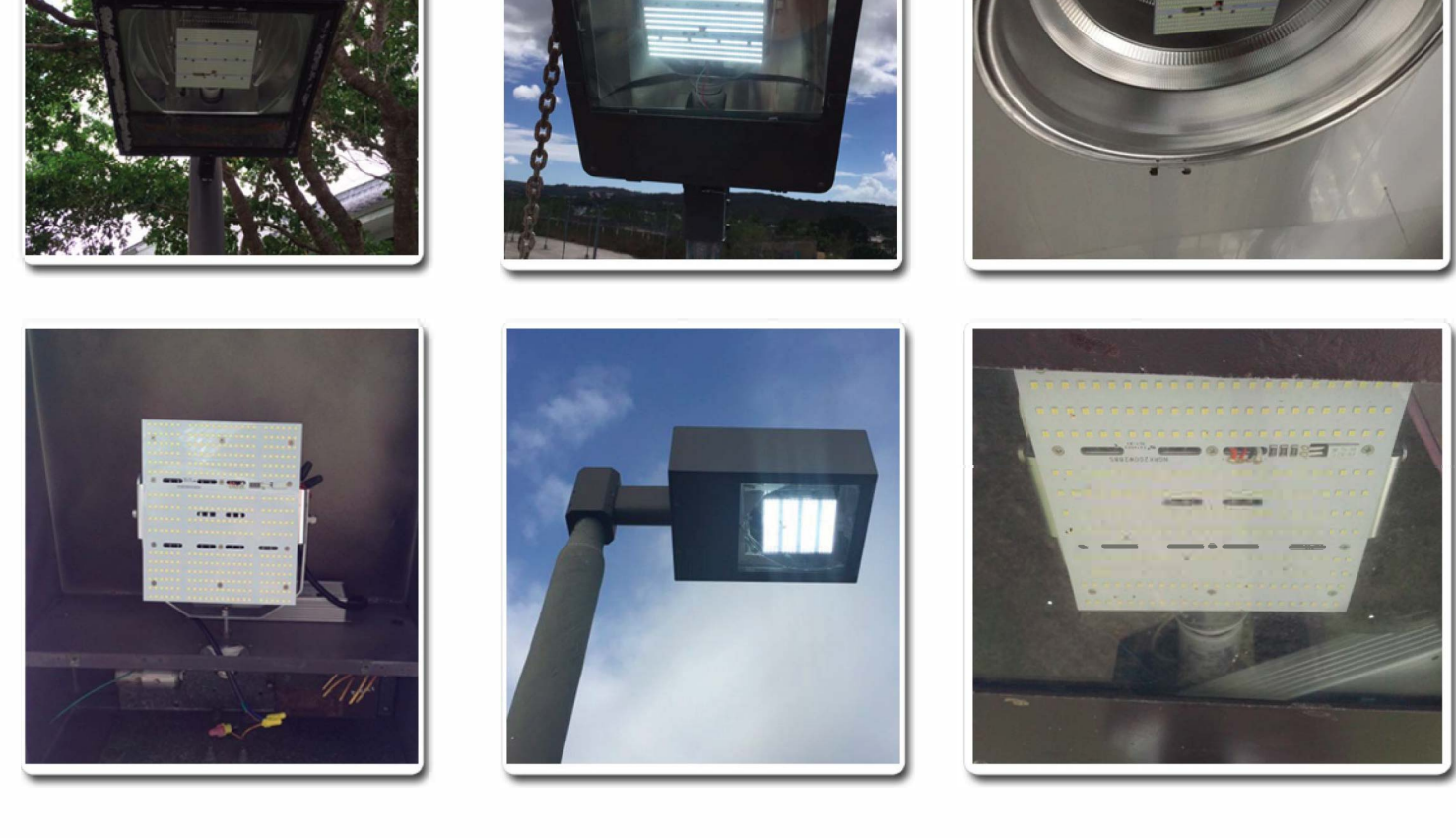

WWW.ECOMAXLIGHTING.COM